

# OFFICIAL PICKLE-BALL® COURT

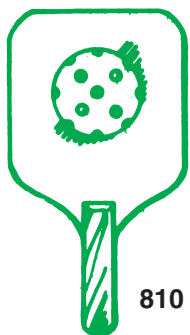
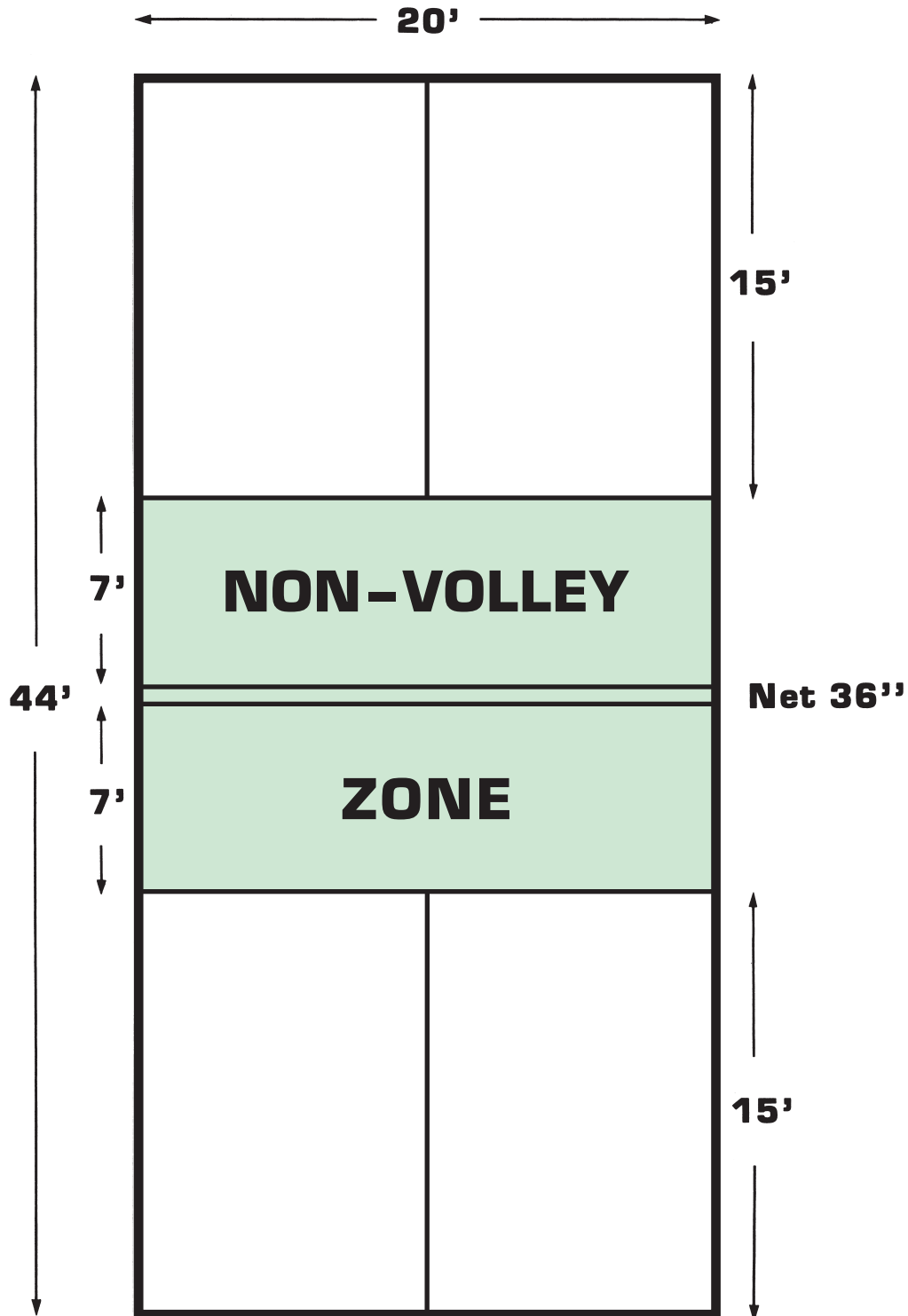

**A FUN COURT GAME**  
Keen Competition at All Levels of Ability

**PICKLE-BALL**, Inc.

[www.pickleball.com](http://www.pickleball.com)  
[info@pickleball.com](mailto:info@pickleball.com)

810 N.W. 45th • Seattle, WA 98107 • (206) 632-0119 • 1-800-377-9915 • FAX # (206) 632-0126

Pickle-Ball® is a registered trademark of Pickle-Ball, Inc. © 1972, 2005 by PICKLE-BALL, INC.

## PICKLE-BALL DOUBLES STRATEGY

Pickle-Ball involves strategies that include lobbing, overhead slamming, passing drive shots from the baseline, and fast volley exchanges at the net. The key strategy to remember is that the team that reaches the front court in a net volley position first will be in the best position to win the point. Again, the most effective position of play is when both players on the same team are side-by-side in the attack position one foot behind the non-volley zone line.

### PLAYER POSITION ON THE COURT (SEE OPPOSITE PAGE FOR MORE DETAILS)

The serving team will be side-by-side on the baseline in a defensive position ready to return passing drive shots, drop shots, and overhead slams. The serving team must stay back until the ball has bounced once on their side prior to moving forward to the net volley position. The receiving team will have the player not receiving the serve in the net volley position. The player receiving the serve should play 1-2 feet behind the baseline to anticipate the deep serve of the opposing team. The receiving team player should hit a deep return of service shot and move forward to the net volley position side-by-side with his partner. This is the ideal attack position for the receiving team as both players are in the *best* position to win the point (receiving team in net volley position hitting overhead slams and drop shots while serving team in defensive position back on baseline attempting passing, drive shots, offensive lobs deep to the baseline, and drop shots that fall into the non-volley zone).

### SHOT SELECTION — RECEIVING TEAM ON OFFENSE

The receiving team in the net volley position may utilize the following shots to win back the serve:

- A. Overhead slams down the middle of the court or angled toward the sidelines.
- B. Drop shots clearing the net and landing in the non-volley zone (a player may move into non-volley zone before ball bounces, but the player must let it bounce before returning it). Drop shots can be effective as the serving team players are back in a side-by-side baseline position prepared for overhead slams. They must rush forward and hit an “off-balance” shot which is usually a “put-a-way” overhead slam or volley by the receiving team. It is to the receiving team’s advantage while at the net volley position to return all possible shots on the fly (not on first bounce). If the receiving team lets an offensive lob bounce than they may relinquish the net volley position as the serving team will seize this opportunity to move forward and gain the net volley position while the receiving team retreats to the defensive position on the baseline.

### SHOT SELECTION — SERVING TEAM OF OFFENSE

Both serving team players will be side-by-side, one foot behind the baseline. The ideal serve is hit hard and deep diagonally to the receiving team player. The advantage of a hard-hit deep serve is the receiving player who returns service will have greater difficulty moving forward and “getting set” in the net volley position. The serving team can take advantage of this deep serve by hitting a short drop shot that will land in the non-volley zone just in front of the on-rushing receiving player who is moving forward to join his partner at the net volley position. *Remember*, the serving team must let the return of service shot bounce once on their side prior to moving forward to the attack position. If the receiving team is set at the net volley position, the serving team can utilize the following shot selection:

- A. Passing, drive shots toward the receiving team player who is moving forward after hitting the return of service shot to establish the net volley position.
- B. The second strategy is lobbing shots deep to the receiving team’s baseline. High, deep lobs drive the receiving players back to the baseline and many times the receiving team will let the ball bounce as they think the ball will fall out of bounds, beyond the baseline. At this point, the serving team seizes the opportunity and can move forward to take the net volley position away from the receiving team.
- C. “*Dink*” or *Drop Shot Strategy* — an effective “dink or drop shot is when the ball lands in the non-volley zone and the receiving team is unable to hit the ball on the fly without faulting (hitting ball on fly in non-volley zone). Once the receiving team lets the ball bounce in the non-volley zone then the serving team rushes to the attack position. Now the serving team has created a situation where they are on equal terms at the net volley position with the receiving team, therefore, creating fast volley exchanges at the net. This short drop shot strategy creates fast and furious volley exchanges between all four players stationed at the net volley position.

Again, Pickle-Ball is a sport where shot placement, steadiness, patience, and tactics have a far greater importance than brute power and strength.

### COURT DIMENSIONS

The court dimensions are identical to a doubles badminton court. Use the doubles badminton court lines on the gymnasium floor and attach the Pickle-Ball net to the badminton/volleyball net standards at a height of 3 feet. Pickle-Ball is the ideal sport for small spaces in churches, private health clubs, and community centers.

## OFFICIAL PICKLE-BALL® RULES

1. **COURT**—The size of the court is 20' x 44' for both doubles and singles. The net is hung at 36" on ends, and hangs 34" in the middle. When laying out a court, allow adequate space at each end and sides of the court boundary lines for player movement. (Three to five feet on ends and one to two feet on sides.) However, it should be noted that many family's play Pickle-Ball with little or no back and side court and enjoy the game.
2. **SERVE**—Player must keep one foot behind the back line when serving. The serve is made underhand. The paddle must pass below the waist. The server must hit the ball in the air on the serve. He is **not** allowed to bounce it, then hit it. The service is made diagonally cross court and must clear the non-volley zone. Only one serve attempt is allowed, **except** if the ball touches the net on the serve and lands in the proper service court. Then the serve may be taken over. At the start of each new game, the 1st serving team is allowed only **one** fault before giving up the ball to the opponents. Thereafter both members of each team will serve and fault before the ball is turned over to the opposing team. When receiving team wins the serve, the player in the right hand court will always start play.
3. **VOLLEY**—To volley a ball means to hit it in the air without first letting it bounce. All volleying must be done with player's feet **behind** the non-volley zone line. NOTE: It is a fault if the player steps over the line on his volley follow through.

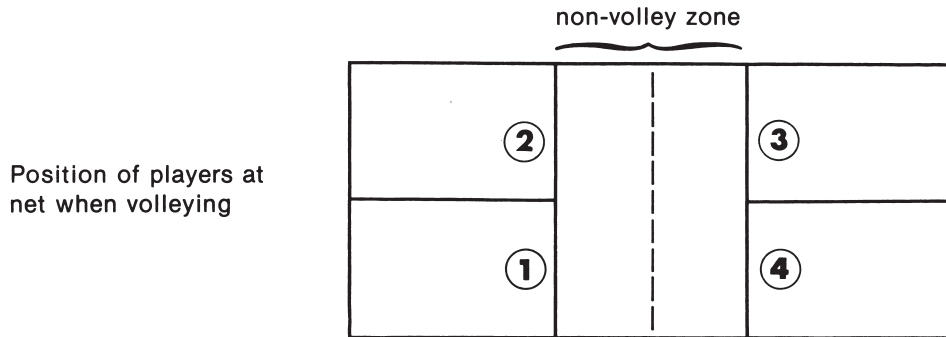

4. **DOUBLE BOUNCE RULE**—Each team must play their first shot off the bounce. That is, the receiving team must let the serve bounce, and the serving team must let the return of the serve bounce before playing it. after the two bounces have occurred, the ball can be either volleyed or played off the bounce.

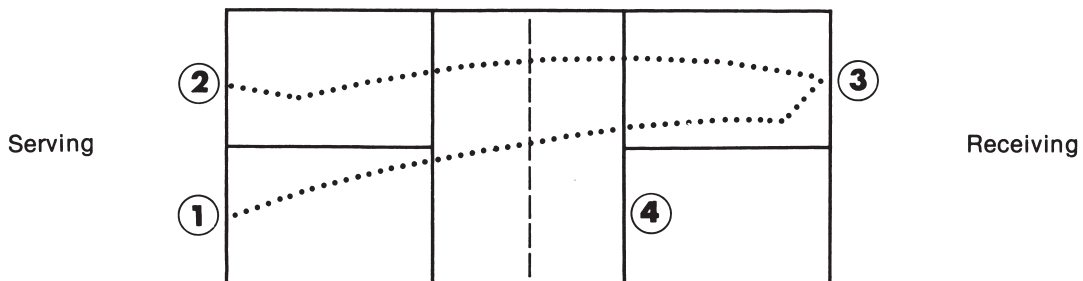

5. **FAULT**—
  - a. Hitting the ball out of bounds;
  - b. Not clearing net;
  - c. Stepping into the non-volley zone and volleying the ball;
  - d. Volleying the ball before it has bounced once on each side of the net as outlined in rule 4.
6. **SCORING**—A team shall score a point only when serving. A player who is serving shall continue to do so until a fault is made by his team. The game is played to 11 points; however, a team must win by 2 points.

### 1. POSITION OF PLAYERS FOR DOUBLES AT START OF GAME

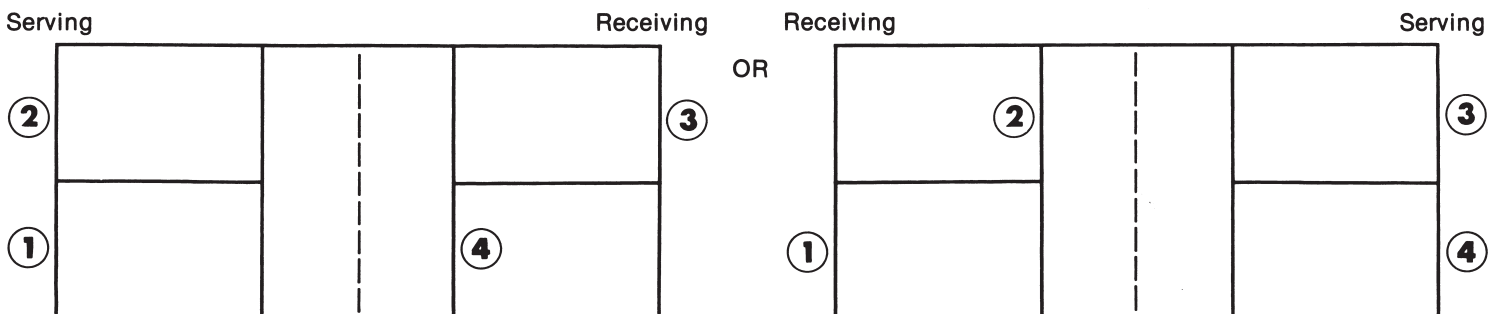

2. **DETERMINING SERVING TEAM**—Players may toss a coin or rally the ball until a fault is made. Winner of the toss or rally has the option of serving first or not serving first.

3. **DOUBLES PLAY**

A. Player in **RIGHT HAND** court (1) serves diagonally across court to receiver (3) in opposite **RIGHT HAND** court. The ball must clear the non-volley zone and land in the **RIGHT HAND** serving court. The receiver (3) must let the ball bounce before returning the serve. Serving team must **also** let the return bounce before playing it. (Rule #4 Double Bounce Rule). After the two bounces have occurred, the ball may then be either volleyed or played off the bounce until a fault is made.

B. If the fault is made by the receiving team, a point is scored by the serving team. When the serving team wins a point, its players will switch courts and the **same** player will continue to serve.

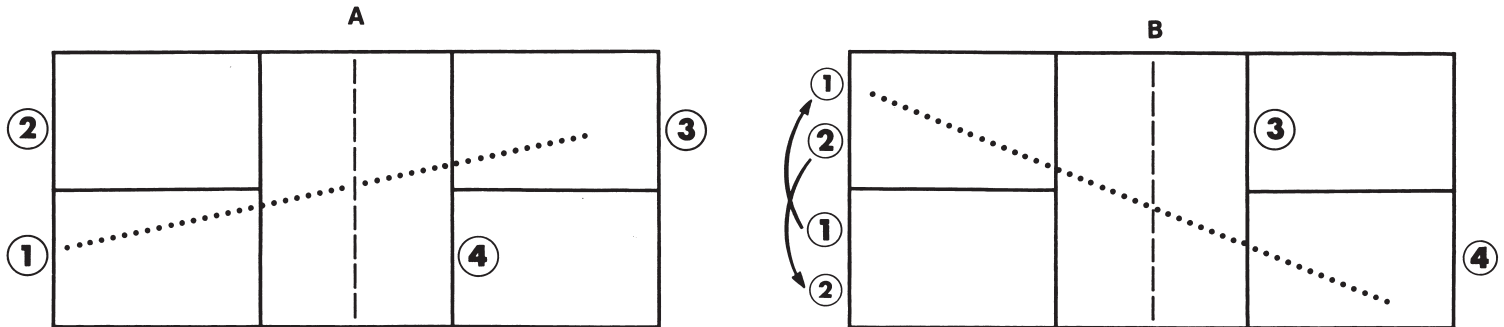

When the serving team makes its first fault, players will stay in the same court and the second partner will then serve. When they make their second fault they will stay in the same courts and turn the ball over to the other team. Players switch courts only after scoring. A ball landing on any line is considered good.

4. **SINGLES PLAY**—All rules apply with the following exception: When serving in singles, each player serves from the **RIGHT HAND** court when his score is 0 or an even number, and from the **LEFT HAND** court when his score is odd numbered.

**BRIEF HISTORY, BUILDING YOUR COURT AND PORTABLE NET STANDARDS**

Pickle-Ball was created during the summer of 1965 on Bainbridge Island — a short ferryboat ride from Seattle, Washington. The original purpose of the game was to provide a sport for the entire family according to the co-inventors U.S. Congressman Joel Pritchard, William Bell, and Barney McCallum. Initially, families played Pickle-Ball in their backyards on a hard surface, on driveways, and on residential dead end streets. Since the mid-1970's Pickle-Ball has grown and expanded from a family activity game to a net court sport with formalized rules and is currently being played in thousands of educational institutions, parks and recreation centers, correctional facilities, health clubs, corporate fitness centers, and on multi-purpose courts at family residences.

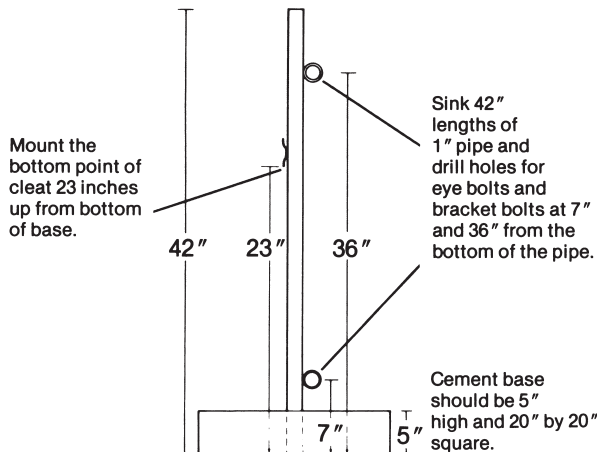

1. Court Size — Playing dimensions - 20' x 44'. Ideal Pad Surface Size - 22' x 54'. Court diagonals - 48' - 4".
2. Net standards should be set one foot from the outside court sidelines in the center of the court.
3. The lines should be made 2" wide and fall on the inside of the length and width measurements. The Non-Volley Zone line is made inside the 7' measurement. The center line should split center measurement, but does not pass through the Non-Volley Zone.
4. Only official Pickle-Ball equipment will be utilized during Pickle-Ball tournaments sanctioned by the U.S. Pickle-Ball Association.